

# ECOGROUNDS QUICK REFERENCE GUIDE FOR 1 GALLON BREWER

## OPENING PROCEDURES

- Turn on brewer if turned off at night
- Remove sprayhead(s) from cleaning solution, rinse and insert into brewer
- Check the "Best By" dates on all coffee bags and discard all expired coffee
- Brew iced tea and iced coffee (if applicable)
- Drain the water from all coffee pots
- Label coffee pots
- Brew coffees of the day starting with the most popular coffee
- Stock sugars and sugar substitutes, napkins, stir sticks, lids, and cup sleeves
- Stock Bewley's hot teas
- Fill dairy pitchers (nonfat / skim, half & half, lowfat, etc)
- Ensure garbage cans are empty

## BREWING PROCEDURES

- ① Open the appropriate number of 2.9 oz frac packs and pour coffee into a paper filter

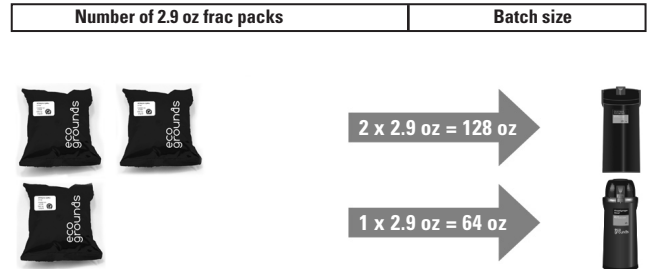

- Insert paper filter into brew basket, and insert brew basket
- ② into the brewer
- Place a clean, labeled coffee pot under the brew basket
- ③ Push the "START" button on the brewer. If the brewer has a
- ④ green "READY" light, make sure that it is on prior to brewing. When brewing half batches, remember to switch the brewer into half batch mode prior to brewing
- Set a coffee timer for 2 hours after you press the "START" button
- ⑤ After the brewing is complete, discard the filter and grinds from the
- ⑥ brew basket and rinse out the brew basket
- Close the coffee pot lid and transfer the coffee pot and timer to
- ⑦ the serving area

## COFFEE HOLDING TIMES

- Timers should be set for 2 hours as soon as brewing begins
- Coffee must be re-brewed after 2 hours



## CLOSING PROCEDURES

- Discard all brewed coffee
- Clean coffee pots with coffee equipment cleaner (blue cleaner)
- Remove shuttle seatcups and soak in coffee equipment cleaner once a week
- Fill all coffee pots with hot water overnight
- Remove sprayhead from brewer and soak in coffee equipment cleaner
- Clean area around sprayhead(s) with a damp towel
- Clean all exterior panels of the brewer
- Discard unused milk from pitchers
- Wash and sanitize dairy pitchers and store in a refrigerator overnight
- Wash all drip trays
- Stock Bewley's hot tea
- Stock sugars and sugar substitutes, napkins, stir sticks, lids, and cup sleeves
- Empty garbage cans
- Wipe down all counters and cabinet doors

# DAILY CLEANING

## AIRPOT

Insert 1 cleaning pouch into the brew basket. (No filter required)

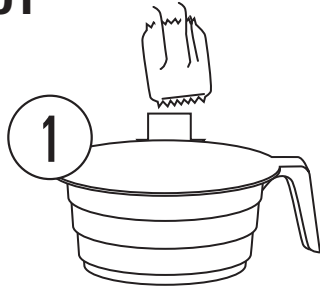

Place dirty coffee pot under the brew basket, then brew one batch of cleaner into the pot.



Allow the cleaner to soak inside the pot for 2 minutes.



Close the coffee pot and pump the lid 5 times into the next dirty pot.

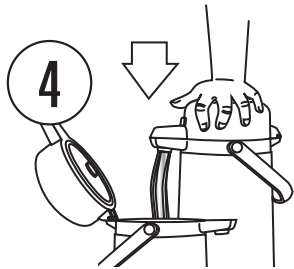

Empty the remaining cleaner into the next dirty coffee pot. Repeat steps 3-5 until all pots have been cleaned.

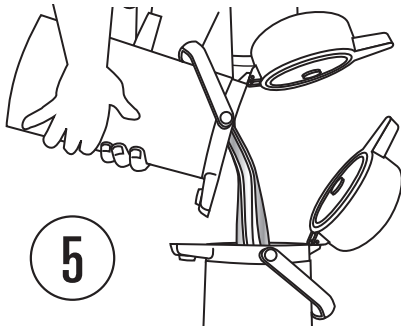

Fill the coffee pot with hot water overnight to ensure hot coffee the next day.

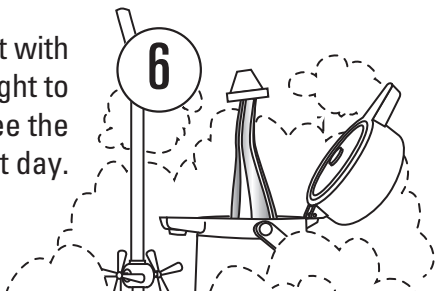

## SHUTTLE

Insert 2 cleaning pouches into the brew basket. (No filter required)



Place dirty coffee shuttle under the brew basket, then brew one batch of cleaner into the shuttle.



Allow the cleaner to soak inside the shuttle for 2 minutes.



Using the faucet on the coffee shuttle, drain the cleaner into the next dirty shuttle. Repeat steps 3-4 until all the shuttles have been cleaned.

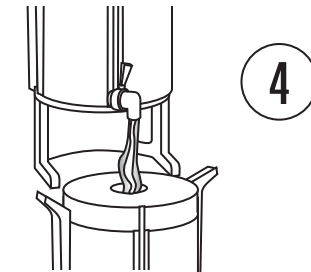

Rinse out the inside of the coffee shuttle with water.

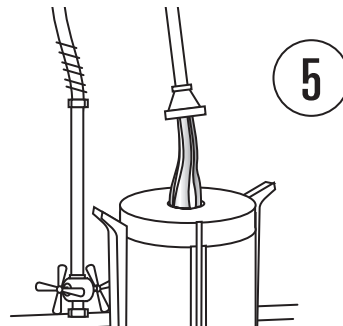

Once a week: Remove the rubber seat cup and wipe away any coffee oils.

